

AMBIUS



SECURITY RANGE

J. A. Russell Ltd
ELECTRICAL & DATA SUPPLIERS

Raddcliffe
ELECTRICAL

AMBIUS SECURITY LIGHT RANGE



10W SECURITY LIGHT

- ASEC10W** Q5080610
ASEC10WB Q5080620
- Frosted Glass
 - Quick Connect Base
 - Colour Temp Switchable

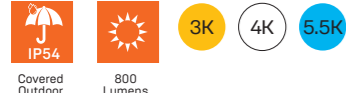

2x10W SECURITY LIGHT

- ASEC20W** Q5080630
ASEC20WB Q5080640
- Frosted Glass
 - Quick Connect Base
 - Colour Temp Switchable

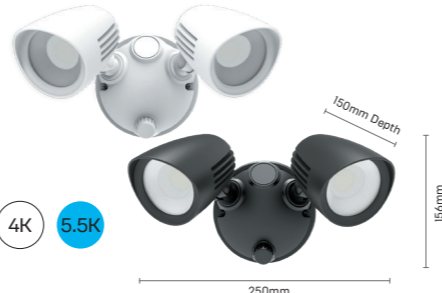

2x15W SENSOR LIGHT

- ASEC30WPIR** Q5080650
ASEC30WPIRB Q5080660
- Frosted Glass
 - Quick Connect Base
 - Colour Temp Switchable

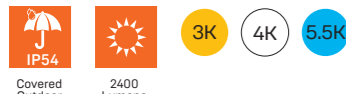

2x20W SENSOR LIGHT

- ASEC40WPIR** Q5080670
ASEC40WPIRB Q5080680
- Frosted Glass
 - Quick Connect Base
 - Colour Temp Switchable

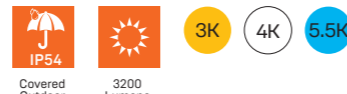

25W MICROWAVE SENSOR LIGHT

- ASEC25WMIC** Q5080690
- Easy Mount
 - 10-2000 LUX adjustment
 - Sensitivity Adj 100%, 75%, 50%, 25%
 - Time adjustment 10sec-12min
 - Distance: 2 - 10m

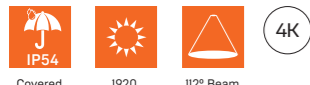
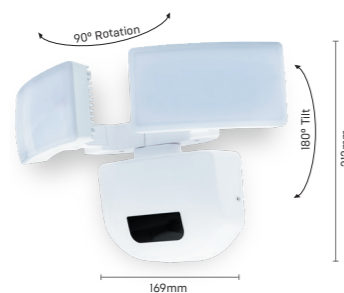

2x10W SENSOR LIGHT

- ASEC38W** Q5080700
ASEC38WB Q5080710
- 10-2000 LUX adjustment
 - Time adjustment 10sec-12min
 - Replaceable PAR38 Lamp

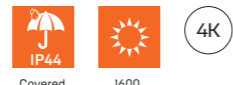

20W MICROWAVE SENSOR FLOOD LIGHT

- AFL20MWSV2** Q5080320
- Die Cast Aluminium Construction
 - Remote Control
 - 20W Integrated LED (LED is not replaceable)
 - Double Insulated

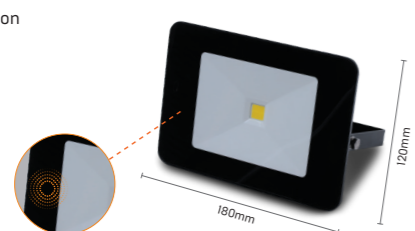

50W MICROWAVE SENSOR FLOOD LIGHT

- AFL50MWS** Q5080340
- Die Cast Aluminium Construction
 - Remote Control
 - 50W Integrated LED (LED is not replaceable)
 - Double Insulated

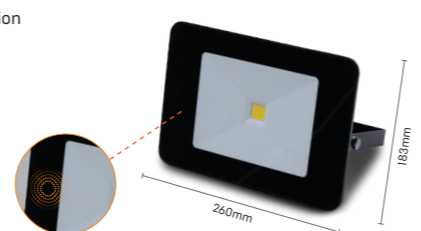

PIR SENSOR RANGE

The Ambius Sensor range of 6 models provides a product to meet most applications including: Interior and exterior recess installation (including IP65), surface mount options on both vertical and horizontal surfaces and 40mm mini recess model.

PIR SENSOR

- ASLPIRW** Q5080080
ASLPIRB Q5080060
- 1200W Incandescent
 - 300W LED
 - 10sec-7min
 - 10-2000 LUX adjustment



SENSOR WALL MINI

- ASECPiRWALL** Q5080940
- 2000W Incandescent
 - 1000W LED
 - 10sec-7min
 - 10-2000 LUX adjustment

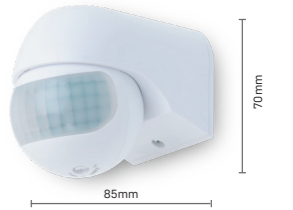

SENSOR SURF WALL & CEILING

- ASECPIRDUO** Q5080960
- 2000W Incandescent
 - 1000W LED
 - 10sec-15min
 - 10-2000 LUX adjustment
 - Twin Sensors

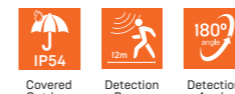
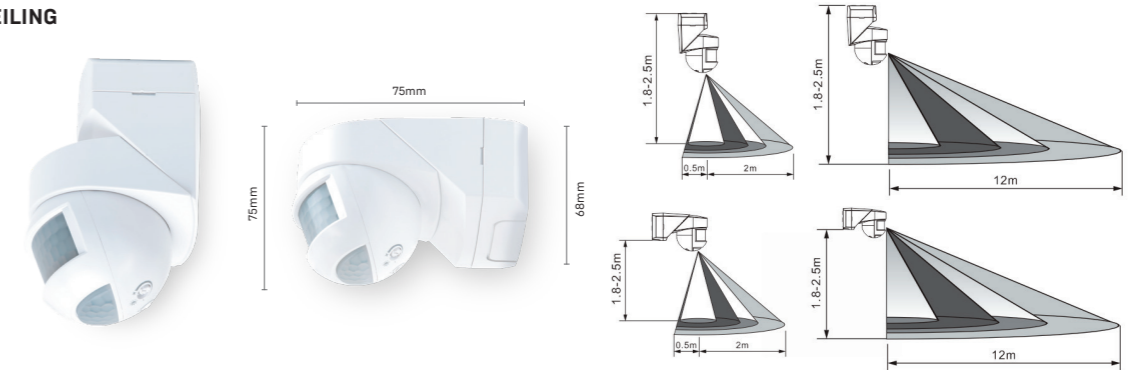

SENSOR RECESS

- ASECPIRIP65** Q5080950
- 1200W Incandescent
 - 300W LED
 - 10sec-7min
 - 10-2000 LUX adjustment

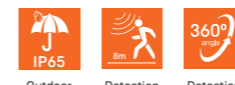
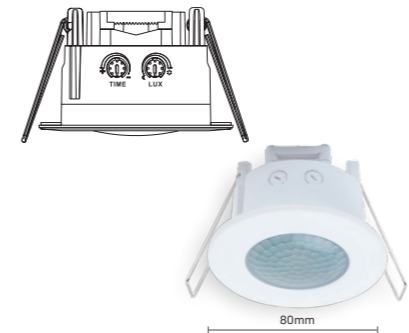

SENSOR RECESS MINI

- ASECPIRMINI** Q5080930
- 800W Incandescent
 - 400W LED
 - 10sec-7min
 - 10-2000 LUX adjustment

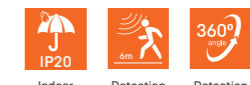

SENSOR RECESS & SURFACE

- ASECPIR** Q5080910
- 2000W Incandescent
 - 1000W LED
 - 10sec-7min
 - 10-2000 LUX adjustment
 - Comes with Clips for Recess Installation

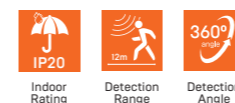

SENSOR RECESS

- ASECPIRTLT** Q5080920
- 1200W Incandescent
 - 300W LED
 - 10sec-15min
 - 10-2000 LUX adjustment

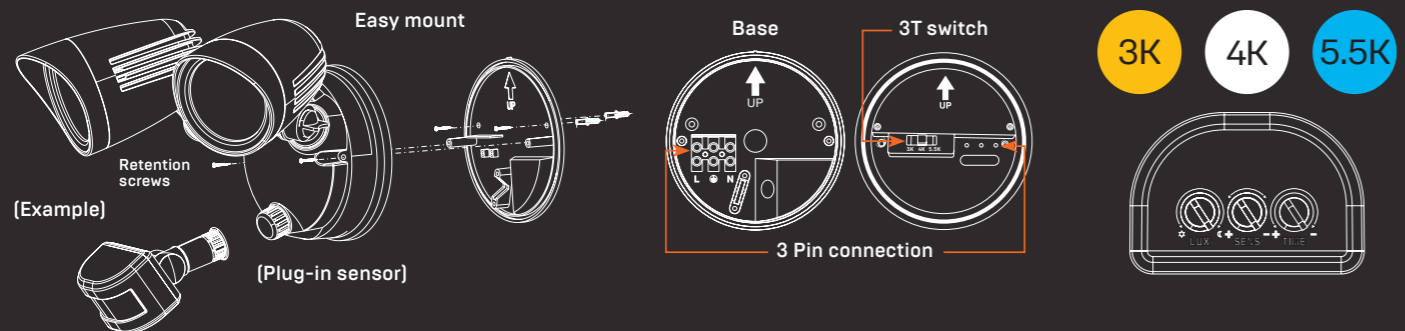

Key Features:

- The Ambius Security Light range comprises 11 models with and without sensors and has the latest user friendly features. There is a model to suit most applications, from basic PAR38 models through to a 25W Microwave sensor model. All using LED, the core range of 10W, 20W, 30W and 40W come in single and double head configurations - black & white
- Base Plate - Easy installation
- Plug in termination - Quick install
- 3 Colour temp internal switch
- Lenze with hood & frosted glass - Glare reduction
- Plug in sensors - easy replacement

AMBIUS SECURITY LIGHT RANGE

Available from

J. A. Russell Ltd Branches

Kaitiaki
5 Whangatahe Dr
Ph: (09) 408 3600

North Shore
8 Hillside Rd
Ph: (09) 444 7339

Glen Innes
41 Morrin Rd
Ph: (09) 570 2181

Pukekohe
175 Manukau Rd
Ph: (09) 239 1387

Matamata
498 Firth St
Ph: (07) 888 4930

Whakatane
27-29 McAlister St
Ph: (07) 306 0310

Hastings
801 Karamu Rd North
Ph: (06) 870 9326

Kapiti
184 Kapiti Rd
Ph: (04) 298 4072

Kerikeri
15 Mill Lane
Ph: (09) 407 0077

Takapuna
58 Barrys Point Rd
Ph: (09) 951 0676

Penrose
25 Fairfax Ave
Ph: (09) 579 1402

Thames
102 Grey St
Ph: (07) 867 9338

Cambridge
4/15 Albert St
Ph: (07) 827 9156

Kawerau
9A Manukorihī Dr
Ph: (07) 323 1200

Bell Block
244 Connett Rd
Ph: (06) 769 9616

Masterton
212 Chapel St
Ph: (06) 378 7789

Whangarei
118-124 Cameron St
Ph: (09) 438 1107

Waiheke
1 Tahī Rd
Ph: (09) 903 3657

Mt Wellington
48D Carbine Rd
Ph: (09) 588 4042

Whitianga
3/20 Joan Gaskell Dr
Ph: (07) 866 0478

Te Awamutu
60 Vaile St
Ph: (07) 872 0600

Rotorua
8 - 12 Waterford St
Ph: (07) 349 0661

New Plymouth
96 Gill St
Ph: (06) 757 5007

Upper Hutt
7 Jupiter Grove
Ph: (04) 830 6081

Warkworth
1 Morrison Dr
Ph: (09) 425 1140

Boston Road
49 Boston Rd
Ph: (09) 357 4450

Manukau
Cnr Cavendish Dr
& Norman Spencer Dr
Ph: (09) 277 0150

Whangamata
300 Aickin Rd
Ph: (07) 865 6887

Tauranga
19 St John St
Ph: (07) 571 4001

Tokoroa
48 Ashworth St
Ph: (07) 886 4830

Hawera
17 Wellington St
Ph: (06) 278 8594

Parirua
25A Kenepuru Drive
Ph: (04) 237 4580

Silverdale
7 Wainui Rd
Ph: (09) 426 6833

Henderson
66 Central Park Dr
Ph: (09) 836 2611

Auckland Airport
9 Jimmy Ward Cres
Ph: (09) 256 1261

Te Rapa
671 Te Rapa Rd
Ph: (07) 850 5436

Tauriko
59 Taurikura Drv
Ph: (07) 987 2283

Taupo
44 Waikato St
Ph: (07) 378 1988

Wanganui
63 Wilson St
Ph: (06) 348 7660

Lower Hutt
399 Hutt Rd
Ph: (04) 576 2040

Kumeu
7 Shamrock Dr
Ph: (09) 951 0460

Rosebank Road
7/624 Rosebank Rd
Ph: (09) 820 6302

East Tamaki
90 Greenmount Dr
Ph: (09) 273 7450

Hamilton
31 Somerset St
Ph: (07) 847 3233

Mt Maunganui
89 Newton St
Ph: (07) 574 4060

Gisborne
293 Palmerston Rd
Ph: (06) 867 3169

Palmerston North
183 Rangitikei St
Ph: (06) 358 6169

Thorndon
120 Hutt Rd
Ph: (04) 473 9350

Albany
8/2 Tawa Dr
Ph: (09) 414 7300

New Lynn
29 Wolverton St
Ph: (09) 828 3119

Papakura
14 Queen St
Ph: (09) 298 1370

Morrinsville
2A Thames St
Ph: (07) 889 6081

Te Puke
590A Jellicoe St
Ph: (07) 573 5091

Napier
104 Austin St
Ph: (06) 843 5888

Levin
526 Queen St
Ph: (06) 368 3039

Wellington
71 Webb St
Ph: (04) 385 2142

Radcliffe Electrical Branches

Nelson
19 Pascoe St
Ph: (03) 548 5068

Westport
10D Lynchurst St
Ph: (03) 789 6300

Rangiora
645 Lineside Rd
Ph: (03) 313 3356

Hornby
52 Waterloo Rd
Ph: (03) 344 0535

Timaru
9 Arthur St
Ph: (03) 683 1270

Cromwell
39A Barry Ave
Ph: (03) 445 4044

Queenstown
149 Glenda Dr
Ph: (03) 442 2772

Invercargill
15 Victoria Ave
Ph: (03) 218 8774

Richmond
18 Poutama St
Ph: (03) 541 0370

Greymouth
53 Gresson St
Ph: (03) 768 5794

Belfast
1/26 Belfast Road
Ph: (03) 323 9428

Ashburton
155 Moore St
Ph: (03) 307 2233

Dunedin
47 Timaru St
Ph: (03) 456 1400

Wanaka
25 Reece Cres
Ph: (03) 443 1270

Gore
13 Avon St
Ph: (03) 203 9261

Blenheim
98 Middle Renwick Rd
Ph: (03) 579 3344

Hokitika
43A Kumara Junction
H'way
Ph: (03) 755 6426

Christchurch
350 Tuam St
Ph: (03) 379 3008



J. A. Russell Ltd
ELECTRICAL & DATA SUPPLIERS

Radcliffe
ELECTRICAL